

LM-84.4

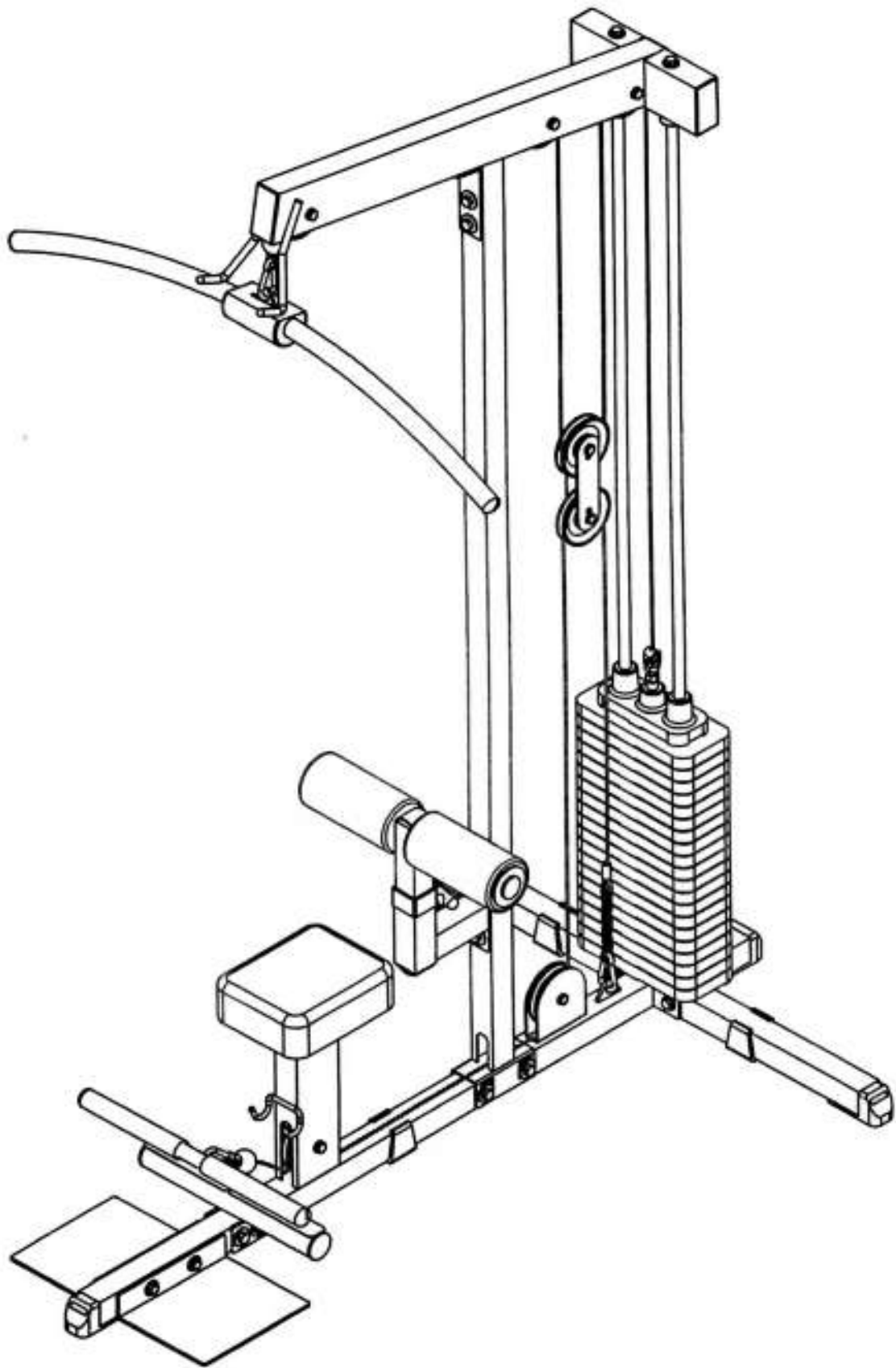

VERSION 0703





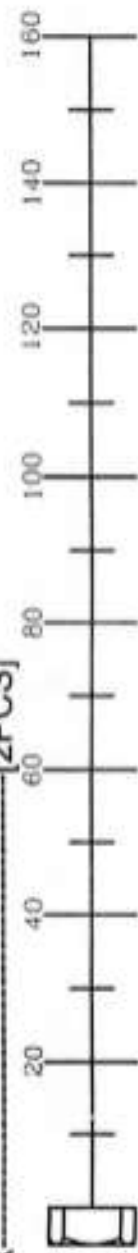
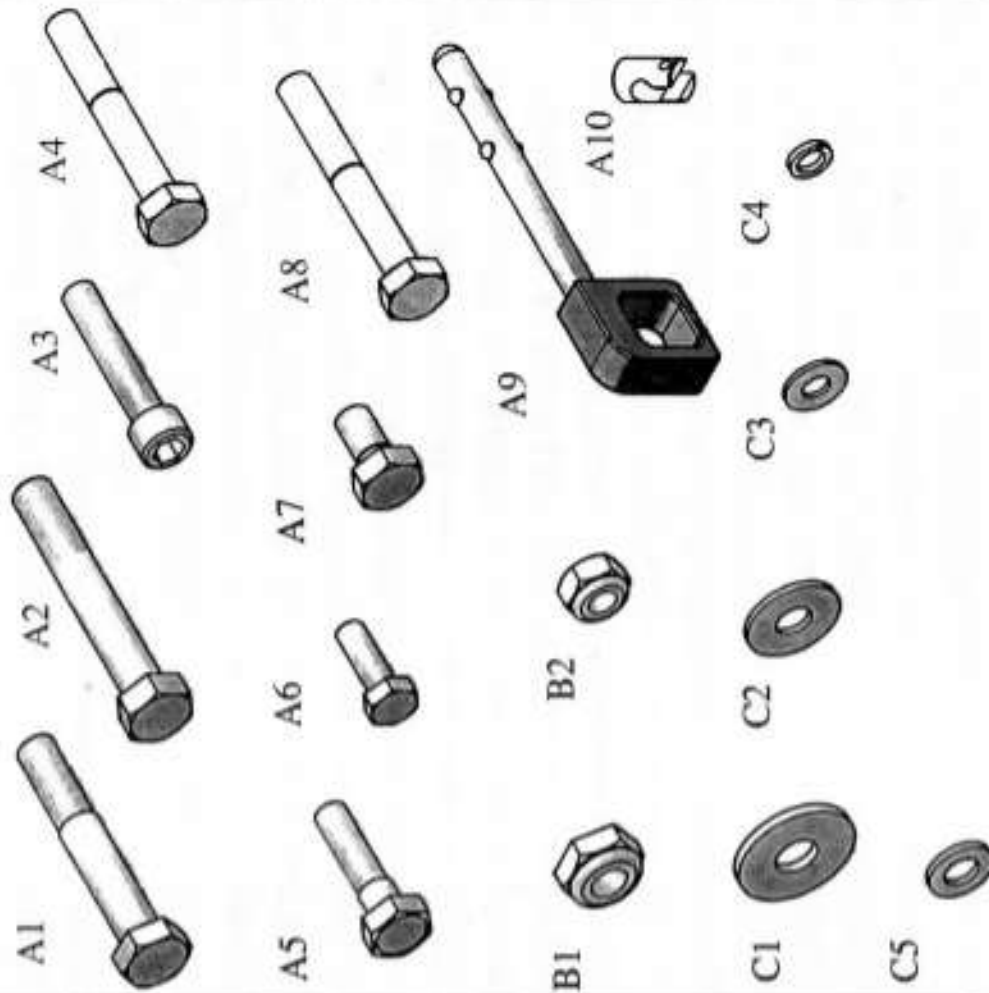

LM-84.4 HARDWARE ILLUSTRATION SHEET







Qty.



- A1.M12X75 HEX HEAD BOLT.....[4PCS]
- A2.M12X80 HEX HEAD BOLT.....[4PCS]
- A3.3/8"X2" ROUND INNER HEX SCREW.....[1PCS]
- A4.M10X70 HEX HEAD BOLT.....[6PCS]
- A5.M10X40 HEX HEAD BOLT.....[3PCS]
- A6.5/16"X1" HEX HEAD BOLT.....[4PCS]
- A7.M10X20 HEX HEAD BOLT.....[2PCS]
- A8.M10X75L HEX HEAD BOLT.....[2PCS]
- A9.BALL PIN (8250019).....[1PCS]
- A10.FIRM SHEATH(8890-010).....[1PCS]
- B1.M12 NYLON LOCK NUT.....[8PCS]
- B2.M10 NYLON LOCK NUT.....[11PCS]
- C1.M12 WASHER.....[16PCS]
- C2.M10 WASHER.....[8PCS]
- C3.5/16" WASHER.....[4PCS]
- C4.5/16" SPRING WASHER.....[4PCS]
- C5.M10xØ19 WASHER.....[2PCS]









LM-84.4 HARDWARE ILLUSTRATION SHEET

Qty.	D1	D2	D3	D4	D5	D6
-----[3PCS]						
-----[4PCS]						
-----[2PCS]						
-----[2PCS]						
-----[4PCS]						
-----[2PCS]						
-----[1PCS]						
-----[2PCS]						
-----[8PCS]						
-----[7PCS]						
-----[3PCS]						
-----[2PCS]						
-----[1PCS]						
-----[1PCS]						
-----[2PCS]						
-----[2PCS]						
-----[1PCS]						
-----[1PCS]						
-----[2PCS]						
-----[2PCS]						
-----[1PCS]						
-----[2PCS]						
-----[1PCS]						
-----[1PCS]						

D7	D8	D9	D10	D11	D12
					

D13	D14	D15
		

D16	D17	D18	D19	D20
				

D21	D22
	

A [1PCS]



C [1PCS]

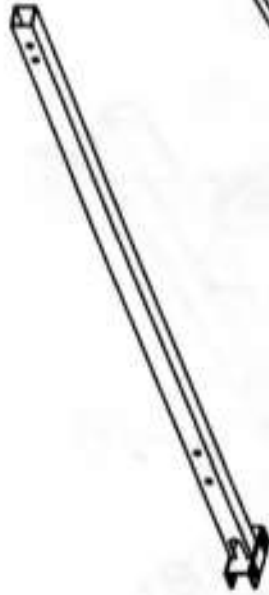

F [2PCS]



N [1PCS]

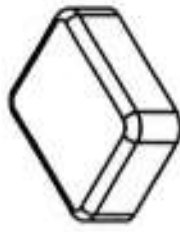

B [1PCS]

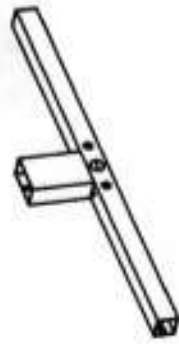

D [1PCS]



E [1PCS]



G [1PCS]



H [2PCS]



I [1PCS]



J [1PCS]



K [2PCS]



L [1PCS]



M [1PCS]



LM-84.4

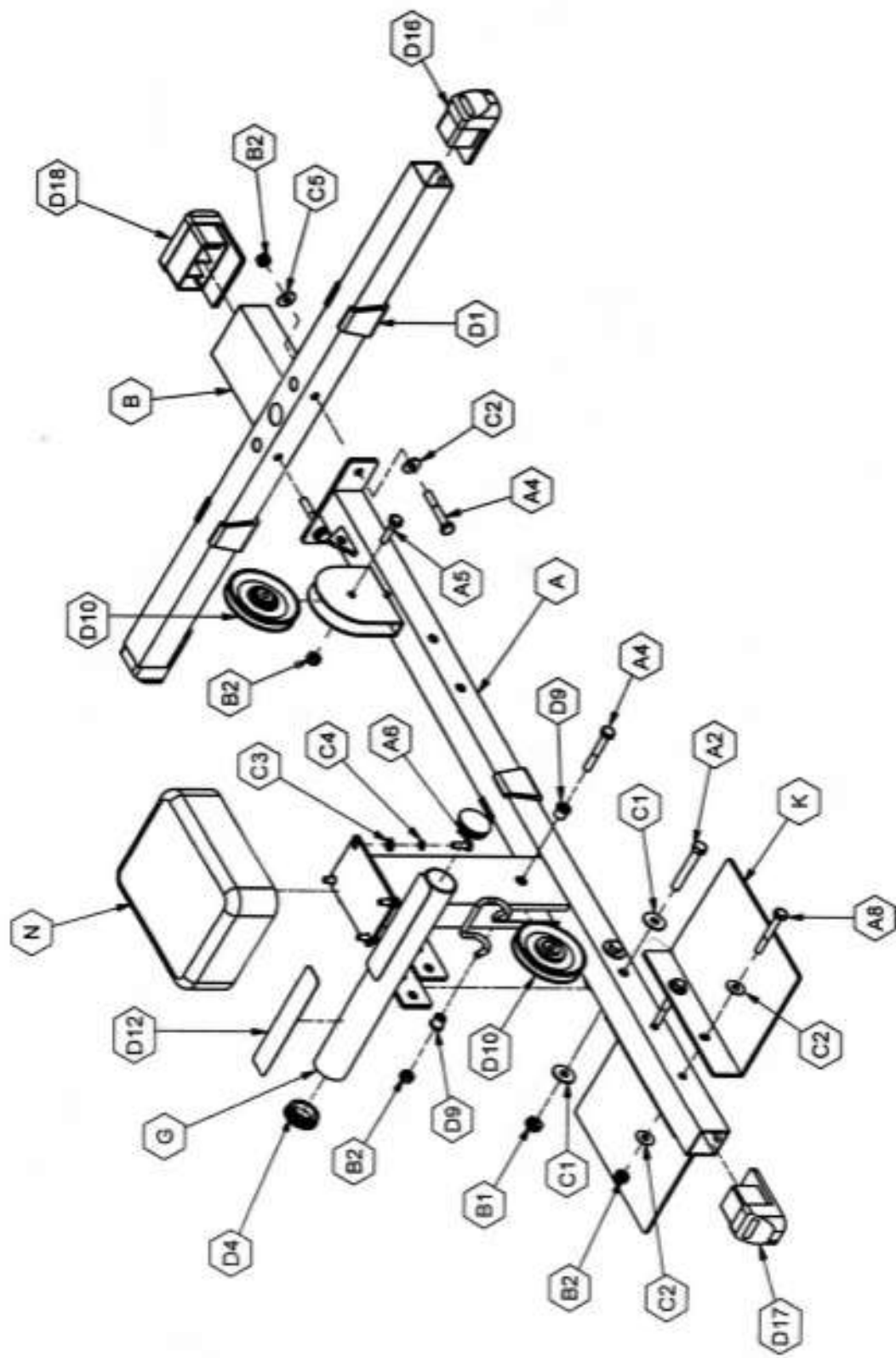

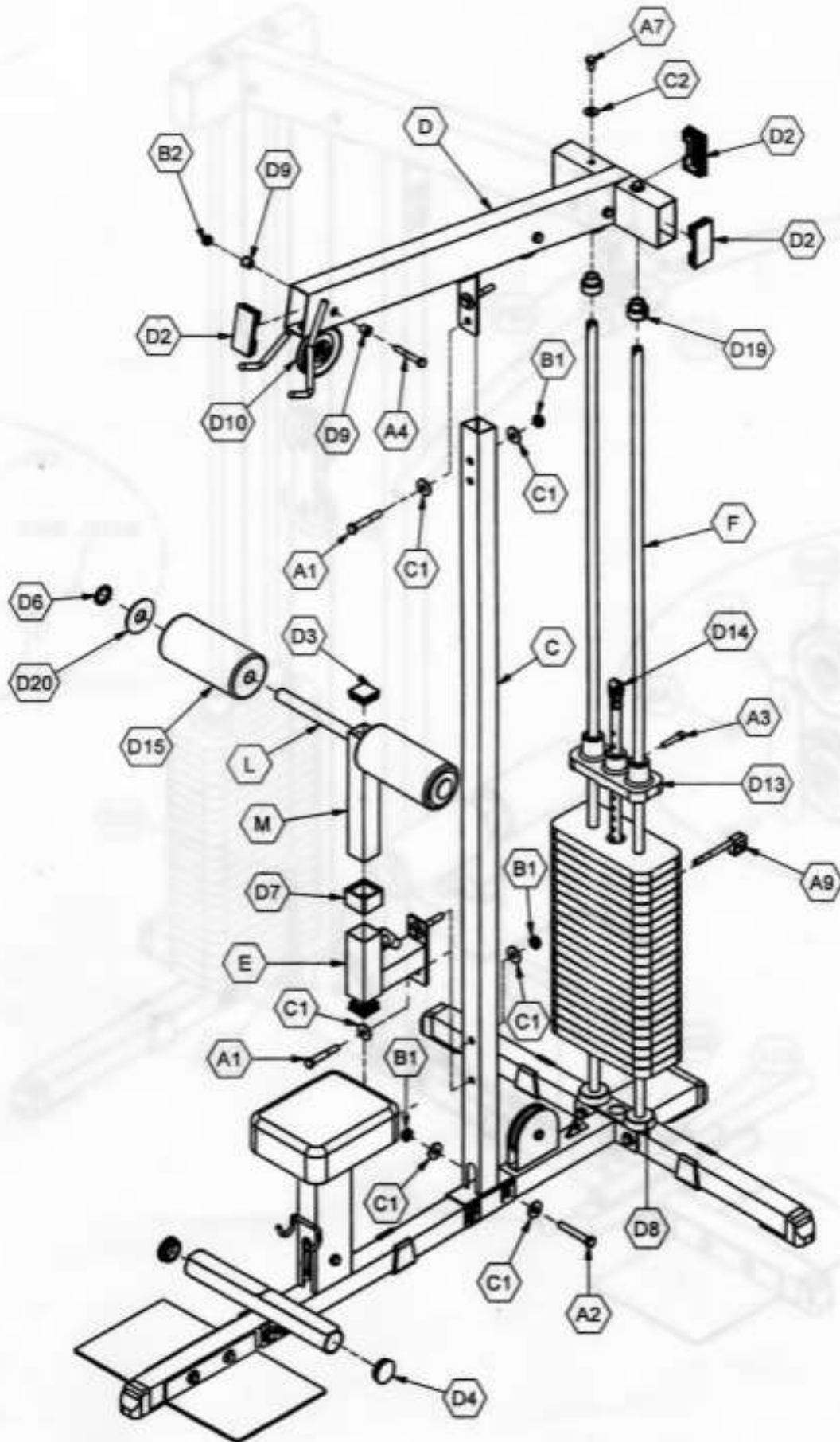

LM-84.4

